

SISTEMI SCORREVOLI IN VETRO

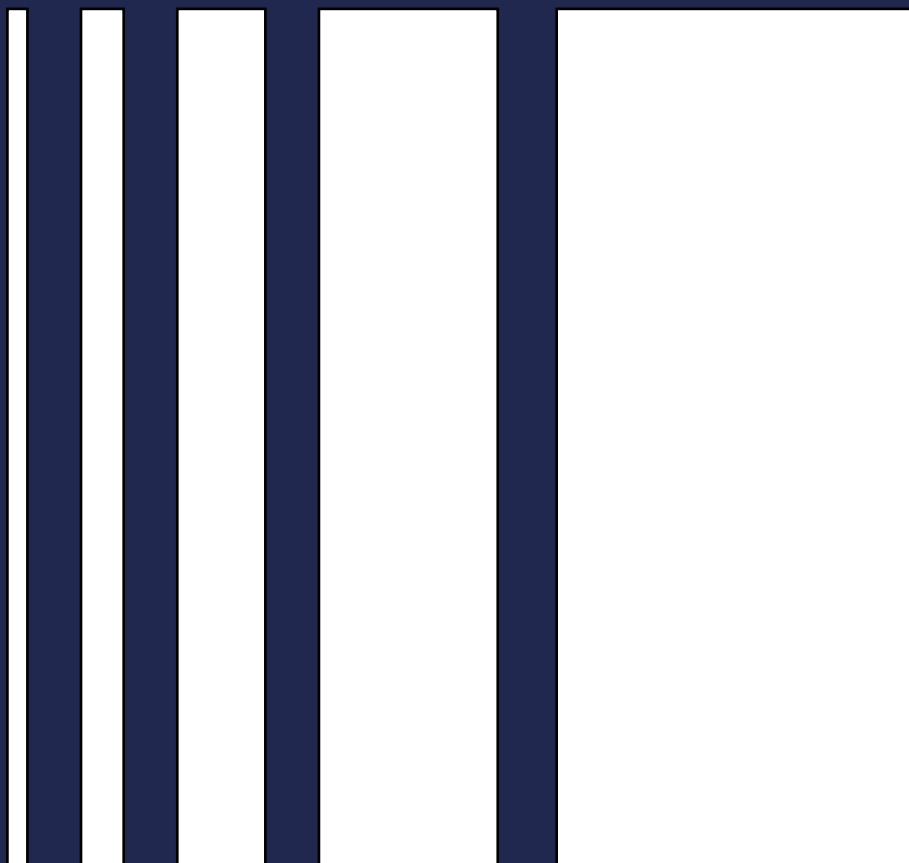

arcarossa

TIPOLOGIA A

PARETI CON MODULI IN VETRO
IMPACCHETTAMENTO IN AREA DI PARCHEGGIO
FISSAGGIO A TERRA (NECESSARIO FORO A TERRA)

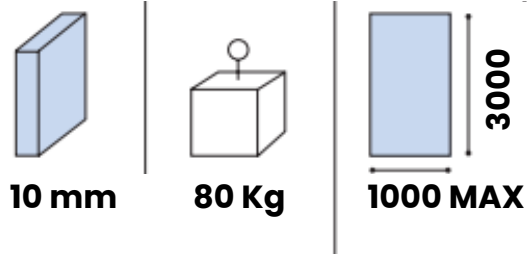

Sistema scorrevole a parcheggio con profili fermavetro continui (L MAX per ogni modulo vetrato è 1000 mm H MAX 3000 mm) completi di catenaccioli ferma-anta a posizionamento esterno regolabile.

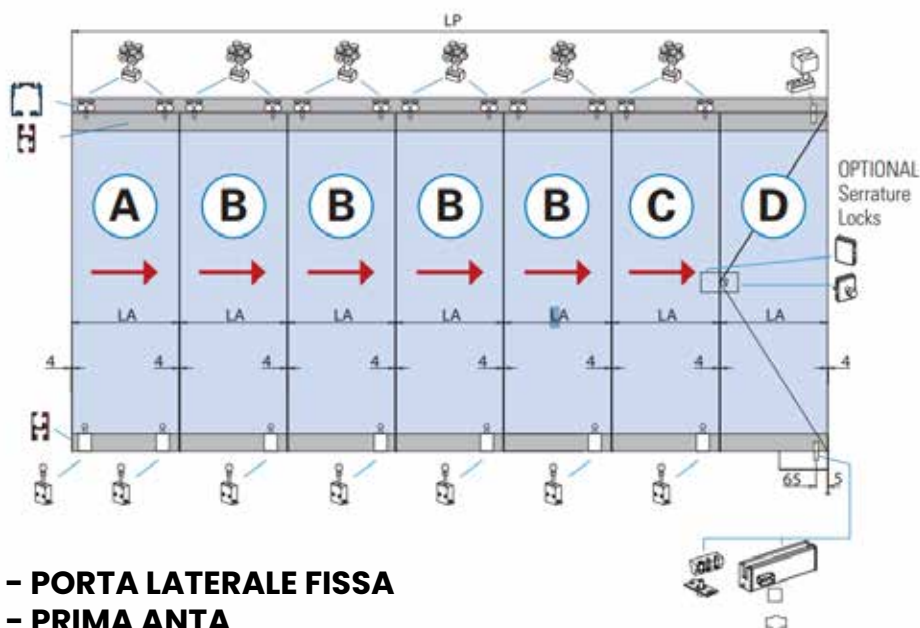

D - PORTA LATERALE FISSA
A - PRIMA ANTA
B - ANTA INTERMEDIA
C - ULTIMA ANTA

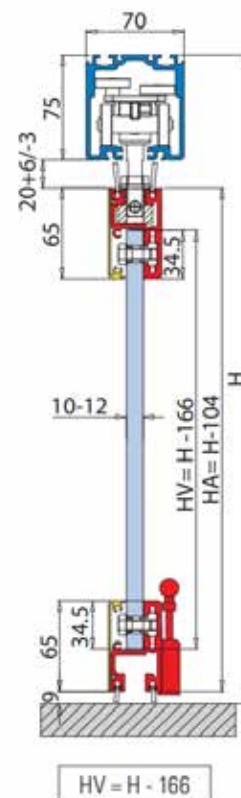

**DETTAGLIO
SEZIONE VERTICALE**

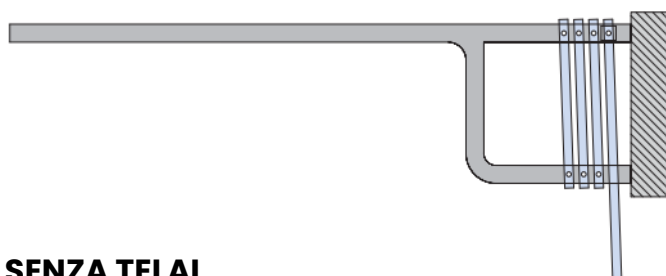

PRO: ANTE IMPACCHETABILI TUTTO VETRO SENZA TELAI

VINCOLI: LA PORTA È SEMPRE NEL LATO DELL'IMPACCHETTAMENTO COME PRIMO MODULO. BISOGNA FORARE A TERRA. SCHEMA DI IMPACCHETTAMENTO UNICO. NON C'È ISOLAMENTO ACUSTICO CERTIFICATO

**SCHEMA DI
IMPACCHETTAMENTO**

TIPOLOGIA B

SISTEMA TELESCOPICO A 2,3,4 VIE

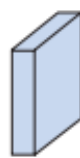

10 mm



100 Kg

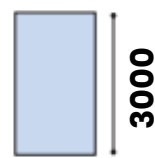

1000 MAX

3000

Sistema scorrevole a scorrimento (L MAX per ogni modulo vetrato è 1000 mm H MAX 3000 mm). Un modulo resta fisso, gli altri (che possono essere 1, 2 o 3 moduli) scorrono in maniera sincrona e si impacchettano paralleli al primo modulo, quello fisso. Il sistema può essere fissato a soffitto o a parete. Le ante possono essere tutto vetro o con telaio in alluminio.



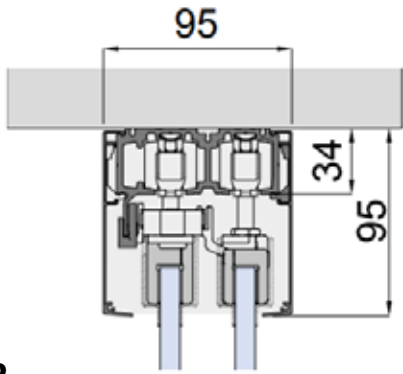

B.2

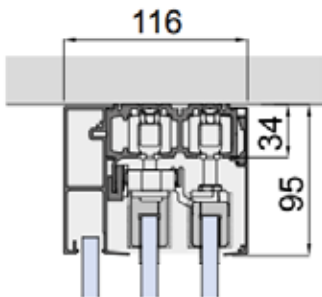
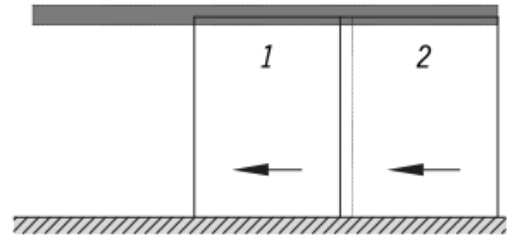

B.3

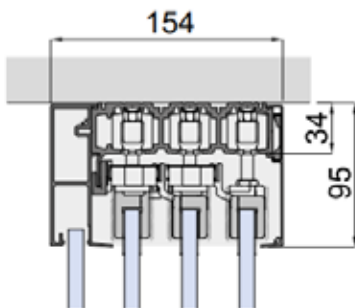
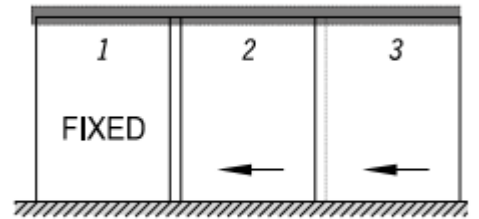

B.4

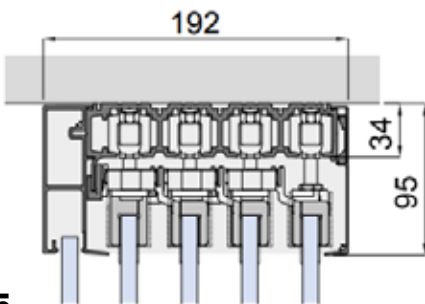
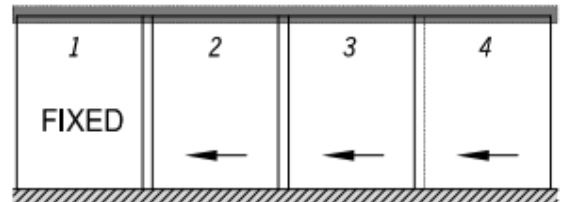

B.5

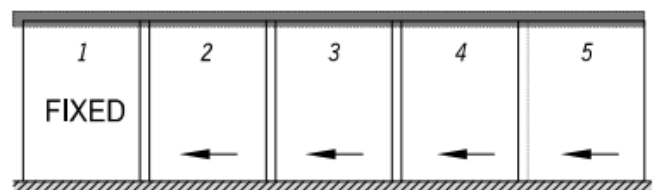

TIPOLOGIA C

SISTEMA A CHIUSURA A LIBRO,
SCORRIMENTO SU GUIDA INFERIORE

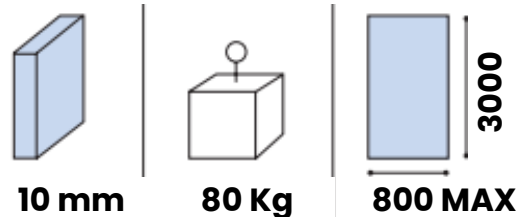

Sistema scorrevole con impacchettamento a libro con scorrimento a terra (L MAX per ogni modulo vetrato è 800mm H MAX 3000 mm). I moduli sono incernierati tra di loro e scorrono per impacchettarsi al principio del binario.

TIPOLOGIE DI APERTURE

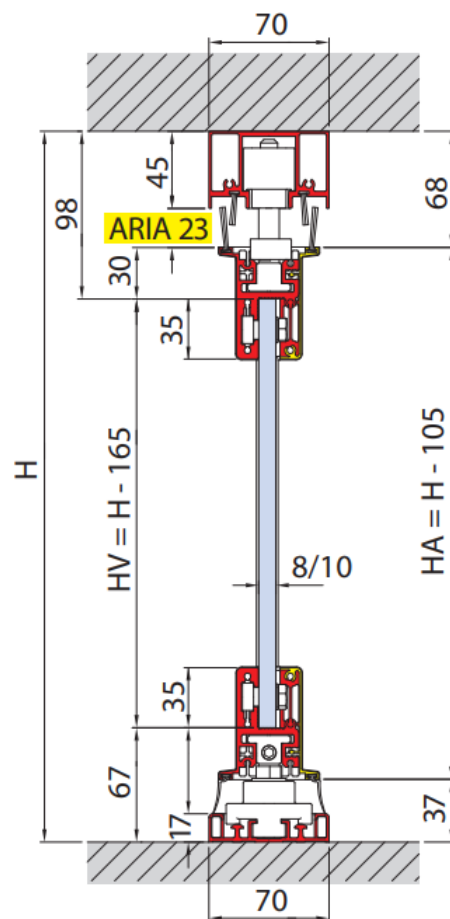
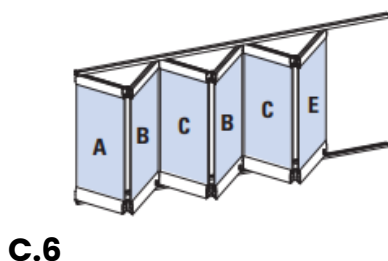
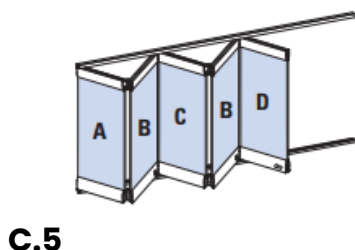
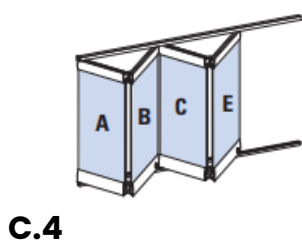
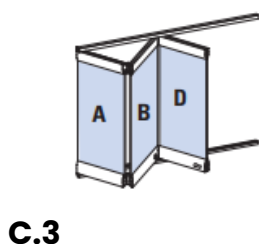
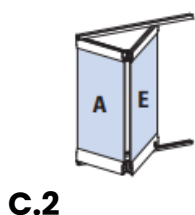

DETTAGLIO
SEZIONE VERTICALE



PRO: ANTE IN VETRO SCORRIMENTO LEGGERO, IL PESO E' A TERRA
VINCOLI: PORTA SE NECESSARIA HA POSIZIONE FISSA ALLA FINE DELLA PARETE. SCHEMA DI IMPACCHETTAMENTO UNICO.

TIPOLOGIA D

PARETE ICONA CON ANTA SCORREVOLE SU BINARIO ANCORATO A SOFFITTO

CON ANTA SINGOLA O DOPPIA CON MOVIMENTO SINCRONO E SLOW STOP. LE ANTE SONO CON MANIGLIONE SENZA SERRATURA. POSSONO ESSERE TUTTO VETRO OPPURE CON TELAIO IN ALLUMINIO. FISSAGGIO A MURO O SOFFITTO.



10 mm



80 Kg

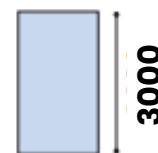

900 MAX

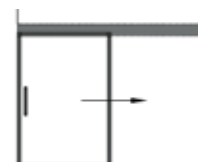

PRO: SLOW STOP INCLUSO, PER LA DOPPIA ANTA IL SISTEMA DI APERTURA E' SINCRONO

VINCOLI: SENZA SERRATURA, L MAX 1800 mm

TIPOLOGIA E

PARETE ROLLING CON SISTEMA TELESCOPICO INTERNO PER FISSAGGIO DEI PANNELLI SENZA FORI O GUIDE AL PAVIMENTO



6 mm

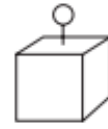

200 Kg

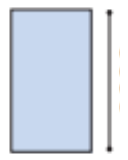

4000

1100MAX

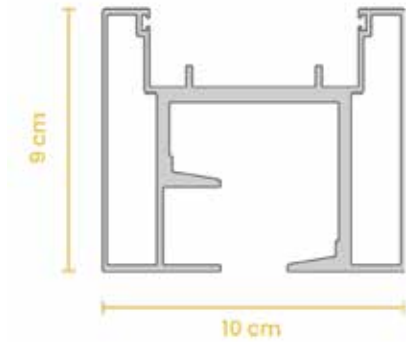

DETTAGLI BINARIO

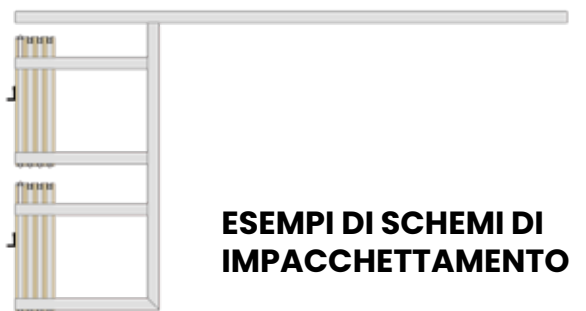

ESEMPI DI SCHEMI DI IMPACCHETTAMENTO

PRO: ALTE PERFORMANCE ACUSTICHE, SISTEMA SENZA FORI A PAVIMENTO O GUIDE, SCHEMA DI IMPACCHETTAMENTO PERSONALIZZATO, BINARIO A VISTA O INCASSATO NEL CONTRO SOFFITTO

VINCOLI: SISTEMA AGGANCIATO AL SOFFITTO (SEGUIRE SCHEMI DI MONTAGGIO IN BASE ALLA TIPOLOGIA DI SOFFITTO E VERIFICARE FATTIBILITA'), MODULO TELESCOPICO SEMPRE CIECO.

